

Bidhaa za usafi wa mazingira kwa bei nafuu
CHOO BORA NA MAZINGIRA SAFI

WILAYA YA CHAMWINO

VIFUPISHO

- . UPM - Politechnic University of Madrid
- . GCSASD - Grupo de Cooperación de Sistemas de Agua para el Desarrollo (Water and Sanitation Systems for Development Cooperation Group)
- . Tsh - Tanzanian shillingi
- . ToT - 'Trainings of Trainers', inatumika kwa wale waliopata mafunzo hayo

VIZIO na VIPIMO

- . ft - futi
- . " - inchi
- . m - mita
- . m³ - ujazo
- . cm - sentmeta
- . l - lita
- . Kg - Kilogram
- . mchanganyo wa uwiano : sementi : mchanga : kokoto
- . mbao ya frem - 1" x 8" x 12 ft
- . wavu - 2,64 x 1,32 m
- . nodo 12mm x 40 ft
- . mfuko wa sementi - 50Kg
- . ndoo - 10l



- . ndoo ya mchanga iliyo jaa - 20.76 Kg
- . ndoo ya mchanga iliyo jaa - 21.96 Kg
- . ndoo ya kokoto iliyo jaa - 20.50 Kg
- . ndoo ya kokoto iliyo jaa - 22.40 Kg

Kwa urahisi wa kutumia, vipimo vilivyopo kwenye katalogi hii vimezingatiwa vile ambavyo hutumika kwenye mazingira yanayotuzunguka, japokuwa vipimo hivyo havifanani:

- . 'ndoo' kwa 'mchanga' na 'kokoto' "Pipa" kwa kiasi kingi cha maji
- . 'mfuko' kwa 'semenit. Kama kiasi ni kidogo, 'Kilogramu' itumike
- . "inchi" (") kwa vipimo ya malighafi vidogo, mfano: unene wa mbao.
- . 'feet' (ft) kwa vipimo ya malighafi vikubwa, mfano: urefu wa mbao

Kwa ukubwa wa tofali za sementi na za kuchoma vitumike kwa makisio kama ilivyooneshwa hapo juu, japokuwa vipimo vya ukubwa tofauti tofauti vinapatikana katika wilaya ya Chamwino.



tofali ya sementi



tofali ya udongo

. Utangulizi.....	4
. Jinsi ya kutumia katalogi hii	5
. Mfumo wa Usambazaji	6
. Mawasiliano ya muhimu	7
. Ngazi ya mabadiliko ya usafi wa mazingira.....	8-9

> AINA ZA VYOO10-15

. Choo cha kawaida cha shimo	11
. Choo cha shimo kilicho boreshwa	12-13
. Choo cha kuvuta maji	14

> AINA MBALIMBALI NA GHARAMA16-29

■ SHIMO	16-19
■ BAMBA	20-23
■ KIBANDA CHA CHOO	24-27
■ VITU VYA ZIADA	28
■ WINAWIA MIKONO	29

Kwanini katalogi hii imeandikwa? :

Kwa ujumla, inabidi changamoto za usafi wa mazingira na afya ambazo sekta ya afya ilikuwa inakumbana nayo karne zilizo pita duniani kote na Tanzania

Kwa mkoa wa Dodoma takwimu za mwisho zilizofanywa wakati wa kuanzishwa kwa mradi wa UMATA zinajieleza zenyewe. Katika wilaya tatu za Bahi, Chamwino, na Kongwa. Utafiti unaonyesha kwamba:

- . Asilimia 22 % tu ya kaya ndio wanapata huduma bora ya Usafi wa mazingira.
- . Asilimia 4 % ya watu wazima ndio wanaojihusisha na unawaji wa mikono.

Hali hii ina athari ya moja kwa moja kwa afya ya jamii, kwa vile usambazaji wa magonjwa ya kuha risha ambao ni gonjwa la tatu kati ya magonjwa kumi yanoyosababisha vifo kwa watoto chini ya miaka mitano kwa Tanzania.

Ambapo ni kikwazo kikubwa sana kwa familia kuondokana na umasikini ambapo ina athiri ngu vu kazi kufanya shughuli za kiuchumi na kupunguza muda wa kufanya shughuri za uzalishaji, na kuathiri afya za familia, maalumu ni kwa watoto ambao wana waathiri wa kina mama na watu wenye mahitaji maalumu na kupungu za utu miongoni mwao.

Wilaya zilizoonyeshwa hapo juu ni kati ya wilaya ishirini ambazo zina idadi kubwa za vifo vya watoto chini ya miaka mitano katika inchi yetu.

Kwa kutatua tatizo hili mipango kazi inatakiwa kufanya kazi kulingana na mahitaji kupitia ma tangazo ya afya na usafi wa mazingira, lakini kwa kutoa motisha kwa wale wanonyesha utayari wa kujenga na kuboresha huduma za usafi wa mazingira kwa bei nafuu na upatikanaji wa urahisi wa bidhaa na vina wafikia jamii.

Kwenye hii sehemu ya pili tatizo limeonyeshwa na katalogi hii imeonyesha namna ya kutatua tatizo hili.

Njia hii iliyotumika ndio iliyoonekana ikitumika Chamwino, maboresho na mapendekezo yalitolewa na mafundi.

Katalogi hii imeandaliwa ili kuwasaidia mafundi na wafanyabiashara kama zana itakayowasai diakatika shughuli zao:





1. Tambua njia sahihi ya mfumo wa usambazaji, pamoja na wauzaji wa jumla (Mfumo wa usambazaji).
2. Anzisha mahusiano kati yenu na viongozi wa serikali za mitaa (Mawasiliano ya muhimu).
3. Elezea kwa wateja aina tofauti tofauti za vyoo na zipi ni nzuri kwa mahitaji yao:

Kama kazi ya kufanya ni ya kujenga au kuboresha choo fundi anaweza kumshauri mteja kwa kupitia na kumuonyesha aina za vyoo na ushauri uliotolewa kwa kila aina ya choo hususani kwa kila pembe ya kurasa ya kila aina ya choo.

Hizi ni alama muhimu ambazo zimetumika katika katalogi hii (chini ya kila kurasa kwa kila choo)

	maji yanayohitajika kumwagia chooni ni kidogo		choo kinata - kiwa kiwe na kinawia mikono		salama kwa watoto
	maji yanaweza kutumika mara nyingine kwa kumwagia chooni		bamba na kibanda vinaweza kutumika kwa mara nyingine		walemavu wanaweza kutumia aina yoyote ya choo kama vitajengwa na kuwekwa vizuri
	maji yanyohitajika kumwagia chooni nimengi sana		mfuniko utumike ili kuzuia harufu mbaya na inzi		
	mtego maji unazuia harufu mbaya na inzi		bomba la kutolea hewa chafu lifungwe na wavu juu ili kuzuia inzi		

4. Elezea wateja gharama zinatoka wapi na andaa gharama za awali kwa ajili ya wateja, wakati fundi na mteja wamekubaliana kazi ya kufanya , cha kwanza makadirio ya gharama yanaweza yakafanywa kwa kuangalia mada za aina mbalimbali na gharama zake. Kwa ujenzi wa choo kipya moja ya vipengele vinne vifuatavyo vinaweza kuchukuliwa:

-  Shimo
-  Bamba
-  Kibanda Cha Choo
-  Vinawia Mikono

Jumla kuu inatofautiana kulingana na aina iliyochaguliwa. Gharama halisi ya mali ghafi hazihusishi usafiri.

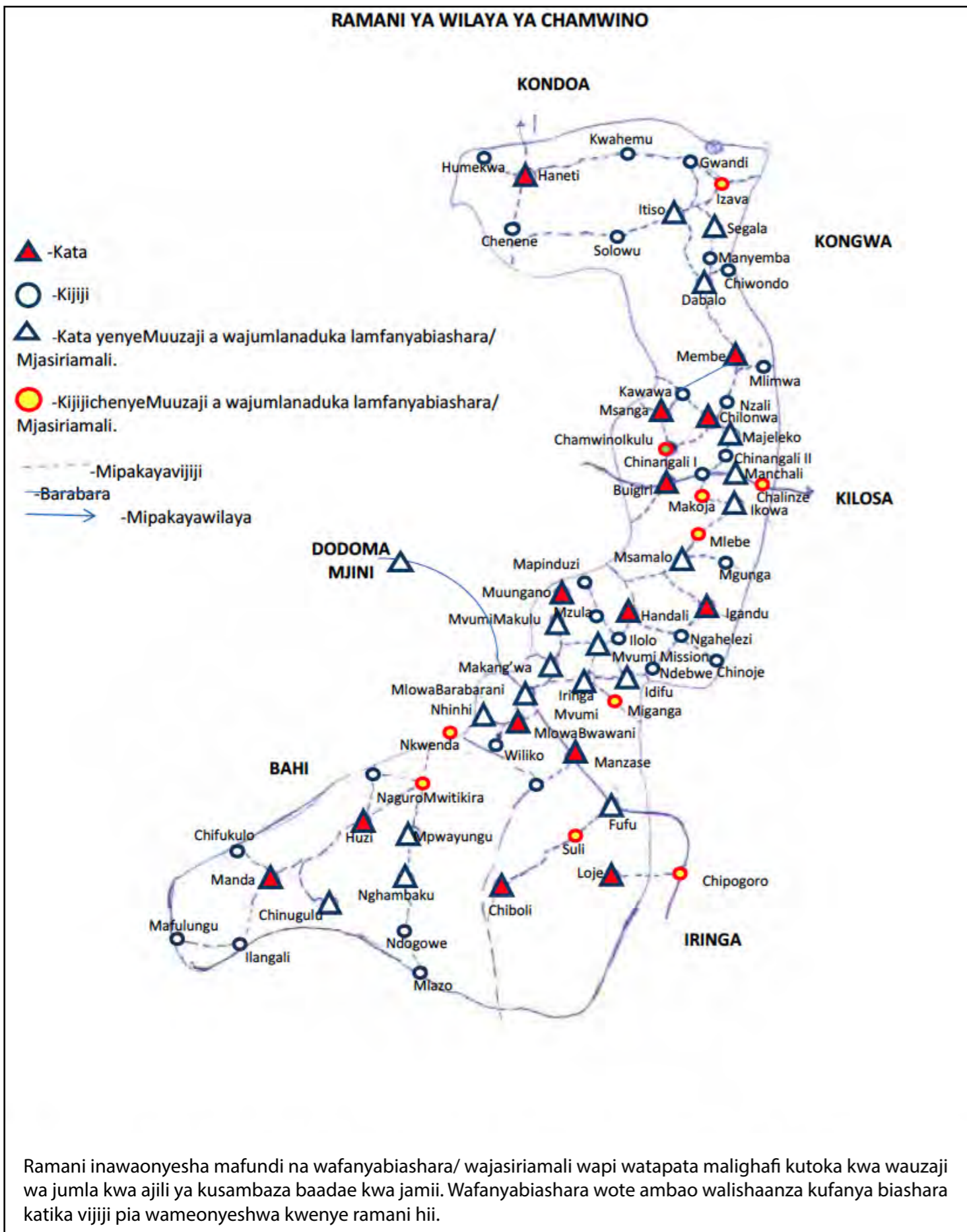

* Andika kwa kalamu ya penseli namba za mawasiliano kwa watu wakupata ushauri, maelezo katika ngazi ya kata

PUGU (Pata Ujuzi Gawia Umma)

Kikundi hiki kimeundwa na watu wane (4) kwa kila kijiji ambao ni mafundi pamoja na Wawezeshaji wa Jamii (CORPs) waliopata mafunzo ya mbinu, Fursa na Mifumo ya Biashara katika Usafi wa Mazingira. Kikundi hiki kwa pamoja ni wahamasiahaji na watoaji wa huduma na ushauri kwa jamii juu ya Usafi wa Mazingira.

NA	KATA	KIJIJI	JINA	NAMBA YA SIMU
1.				
2.				
3.				
4.				

WEO (Ward Executive Officer)

Vifyatulio (Fremu za Mabamba) zitatolewa na Afisa Mtendaji wa Kata husika kupitia kwa viongozi wa vijiji.

NA	KATA	KIJIJI	JINA	NAMBA YA SIMU
1.				

VEO (Village Executive Officer)

Afisa Mtendaji wa Kijiji atahusika katika kutia Saini katika ripoti za maendeleo ya kazi za mradi katika kijiji chake.

NA	KATA	KIJIJI	JINA	NAMBA YA SIMU
1.				
2.				

WAFANYABIASHARA / WAJASIRIAMALI

Kazi yao maalum itakuwa ni kuhakikisha wanatoa malighafi ambazo zinahitajika katika kutengeneza bidhaa za usafi wa mazingira hususani Vyoo na zana nyinginezo kwa jamii inayowazunguka kwa kushirikiana na mafundi.

NA	KATA	KIJIJI	JINA	NAMBA YA SIMU
1.				
2.				

MAFUNDI

NA	KATA	KIJIJI	JINA	NAMBA YA SIMU
1.				
2.				
3.				
4.				
5.				
6.				
7.				
8.				
9.				
10.				

Ngazi hii ya usafi wa mazingira imeandaliwa kulingana na hali ya wilaya ya Chamwino.

Ili kupanda ngazi hii ya mabadiliko ya tabia ya usafi wa mazingira kuanzia na tabia mbaya za uchafuzi wa mazingira, kaya zinatakiwa walau kutumia vinawia mikono, vyoo vyenye bamba linalosafinishika, choo chenye paa na mlango.

Aina mbalimbali za teknolojia za vyoo vimeonyeshwa kuanzia choo cha kawaida hadi choo kilicho bora zaidi:

* Choo cha kawaida cha shimo: shimo la moja kwa moja na bamba lenye mfuniko, kibanda chenye paa na mlango.

* Choo cha shimo kilichoboreshwa na bomba la kutolea hewa chafu:

Choo cha shimo la nje kilichoboreshwa chenye bamba lenye mfuniko, kibanda chenye paa na mlango.

Choo cha shimo la nje cha asili cha kumwagia maji, kibanda chenye paa na mlango.

* Choo cha kusukuma na maji:

Choo cha kusukuma maji chenye mtego maji, kibanda chenye paa na mlango.

Mfano wa kila aina ya choo imeelezewa kwenye mada inayofuata.

HALI YA USAFI WA MAZINGIRA ILIYOBORESHWA

KWA NAMNA GANI CHOO KINAWEZA KUBOresha

*** CHOO CHA KUMWAGIA MAJI**



*** CHOO CHA SHIMO KILICHO BORESHWA**

Choo cha VIP chenye bamba



*** CHOO CHA SHIMO CHA KAWAIDA**



Choo cha VIP cha kumwagia maji cha kienyeji

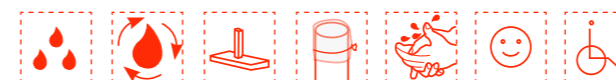

KUJISAIDIA KATIKA SHIMO LILILOTANABAISHWA



KIFUNIKO



SILABU INAYOOSHEKA

KUJISAIDIA SEHEMU ZA WAZI



HALI YA USAFI WA MAZINGIRA AMBAYO HAIJABOreshwa



Choo kilichoboreshwa kama tu kina kifaa cha kunawia mikono na sabuni

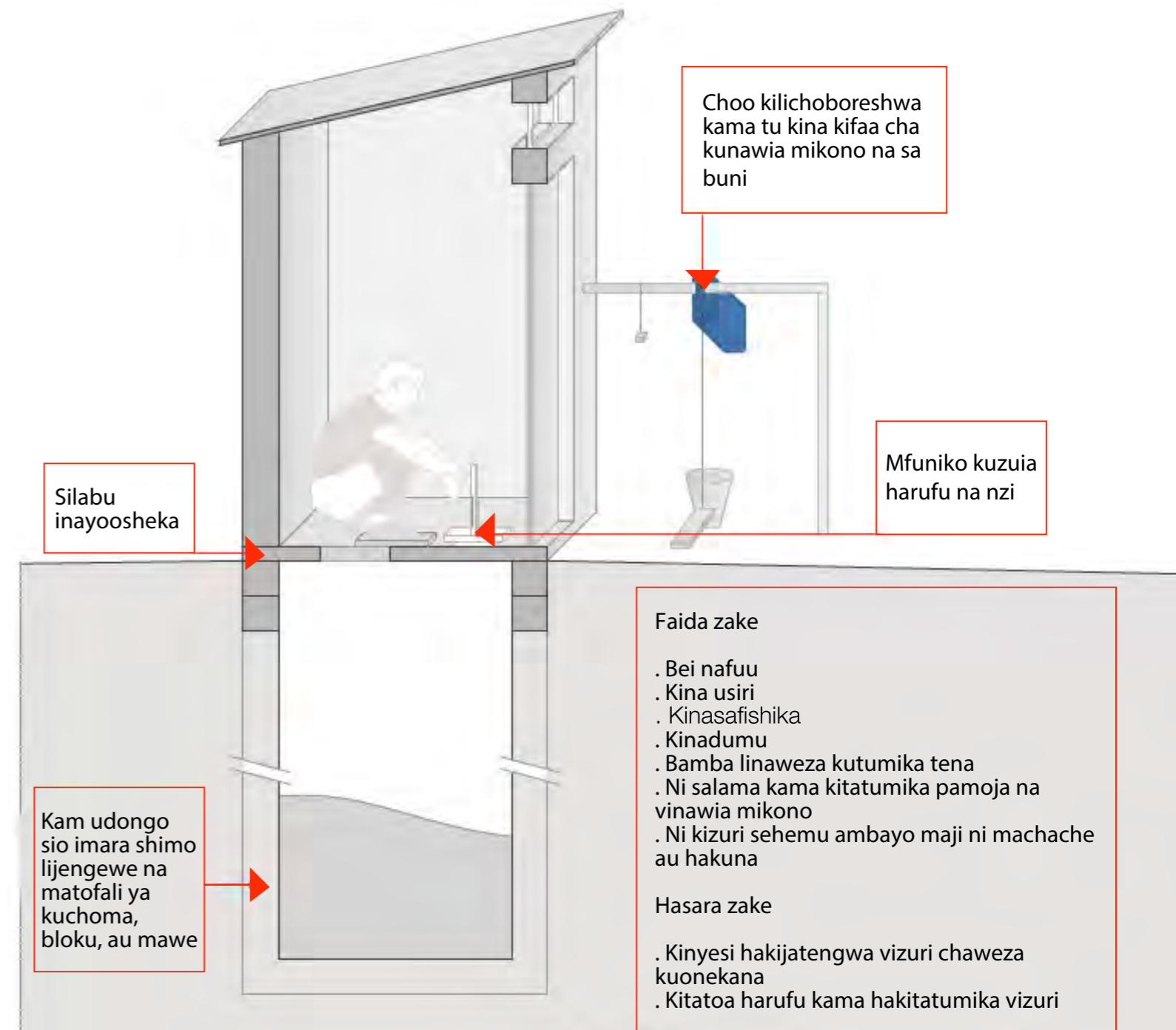

CHOO KILICHOBORESHWA CHA SHIMO LA MOJA KWA MOJA NA BAMBA

CHOO CHA SHIMO LA NJE KILICHOBORESHWA CHA ASILI CHA KUMWAGIA MAJI

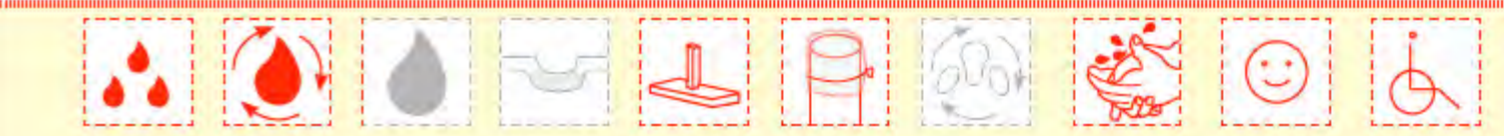
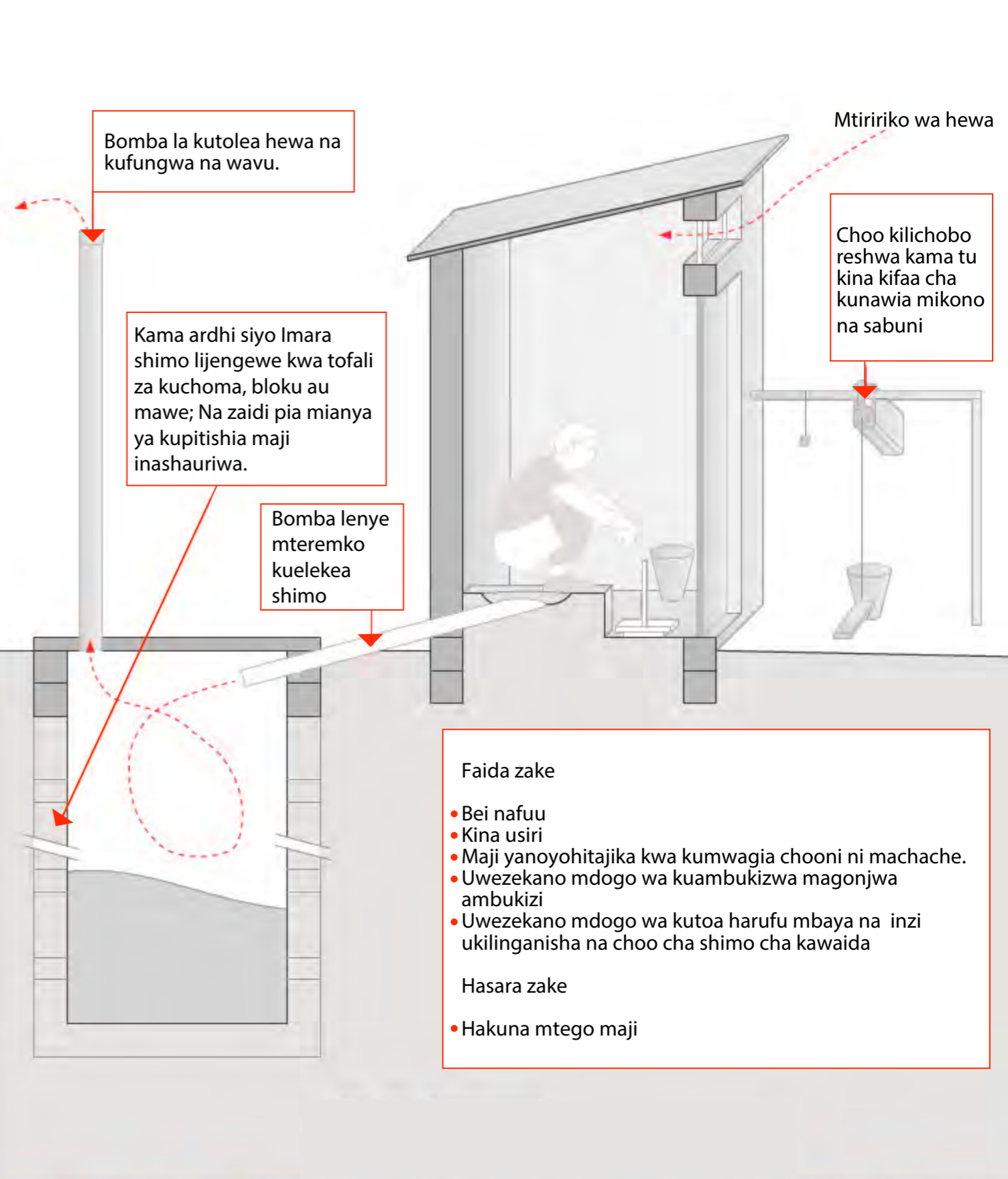
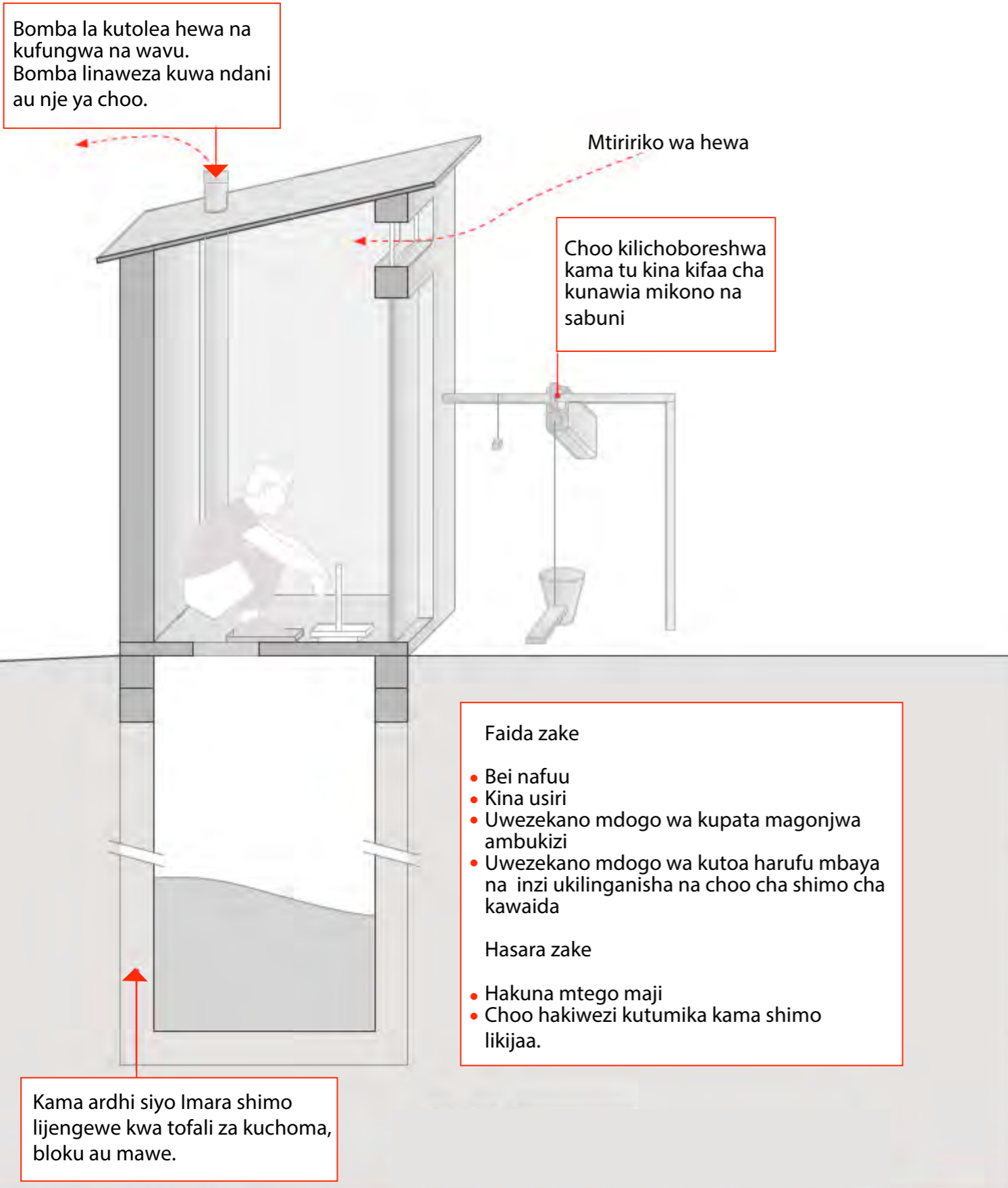

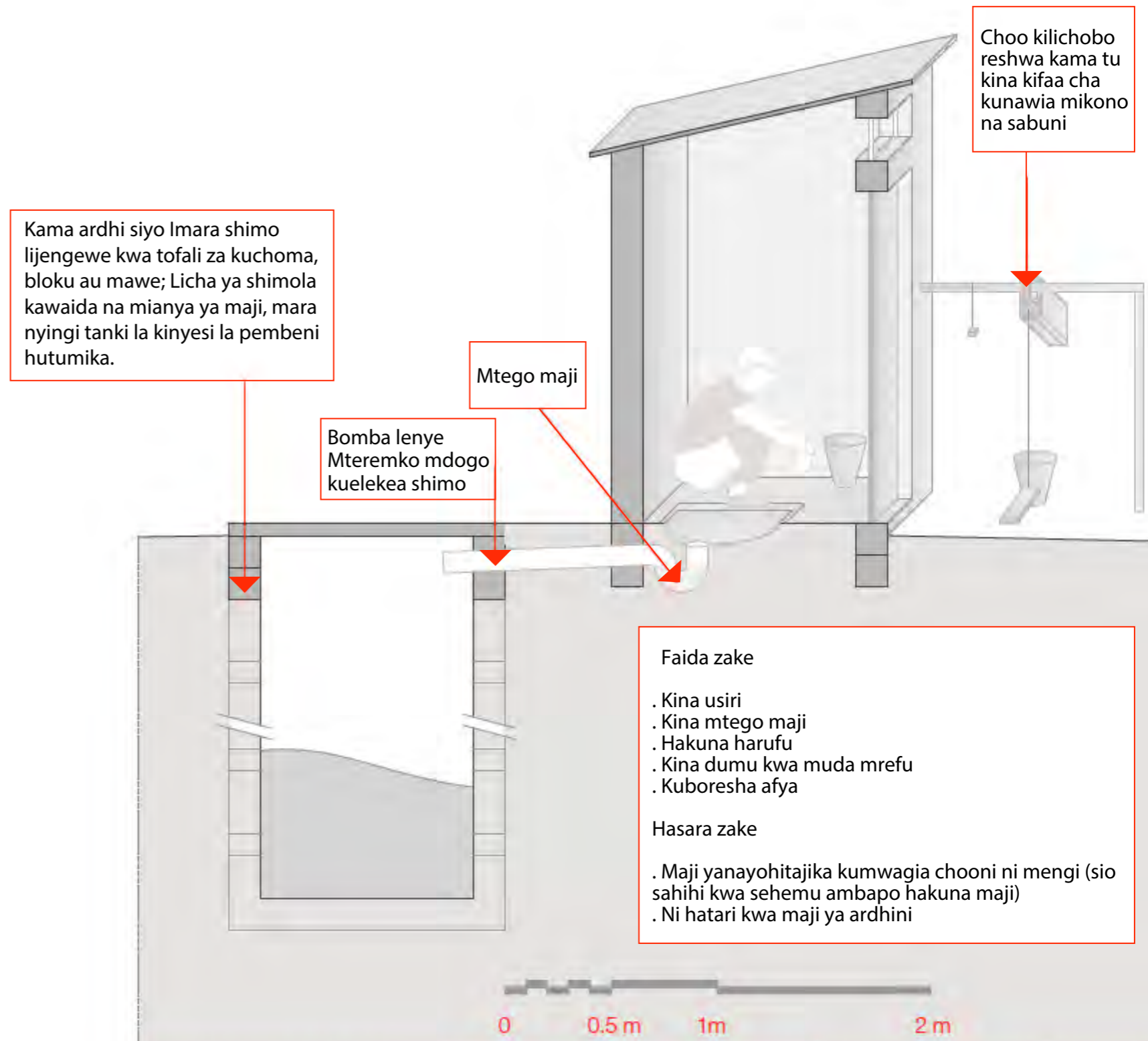

Ushauri:

- . Fanya uchaguzi kulingana na aina ya udongo.
- . Kama ardhi sio imara jengea shimo kwa matofali ya kuchoma, bloku au mawe. Tofali za kuchoma zimechaguliwa na kupewa kipaumbele kwani gharama zake za ujenzi ndani ya shimo ni nafuu ikilinganishwa na aina nyingine.
- . Kama ardhi ni imara jengea sehemu ya juu ya shimo kabla ya kuweka bamba.
- . Kina cha shimo sehemu ambayo chanzo cha maji kipo karibu, umbali kutoka kina cha shimo na chanzo cha maji kiwe Mita 2
- . Kinatakiwa kujengwa umbali wa Mita 30 kutoka chanzo cha maji.
- . Shimo la ndani lililojengewa linatakiwa kuinuliwa juu ipasavyo ili kuzuia mafuriko wakati wa msimu wa mvua.
- . The wind direction should be taken into account to avoid odour issues at home.
- . Shimo linatakiwa kujengwa sehemu ambayo watu hawakai wala kupita.

Udongo wa kudumu:

- . Ukubwa wa shimo uzingatie ukubwa wa choo, idadi ya watu watakaotumia

Saizi inayokubalika (upanana urefu wa shimo unategemeana na ukubwa wa slabu;
Saizi ya Bambakubwa ni 1.5m x 1.5m)

- Kina cha shimo ni Mita 3 na karibu na hapo.
- Unene wa shimo ni Mita 1.5 na karibu na hapo

- . Ukubwa wa shimo unaweza kupimwa kwa kutumia fomula hii:

$$V = \frac{4}{3} \times C \times P \times N$$

V = Ukubwa wa shimo

C = Uwezo wa shimo kubeba uchafu (0.04 m³/mtu/mwaka kwa shimo lilolowana 0.06 m³/mtu/kwa shimo kavu)

N = Mwaka lilipotengenezwa (mwaka)

P = Wingi wa watu uliokadiliwa

4/3 = Shimo lipakuliwe au linyonywe kabla halija jaa, liwe limebaki kwa kiwango cha ¾ kabla ya kujaa

- . Kama shimo limejaa njia rahisi ni kuchimba shimo jingine na kuunganisha na shimo lililojaa au kama picha ya choo inavyoonekana

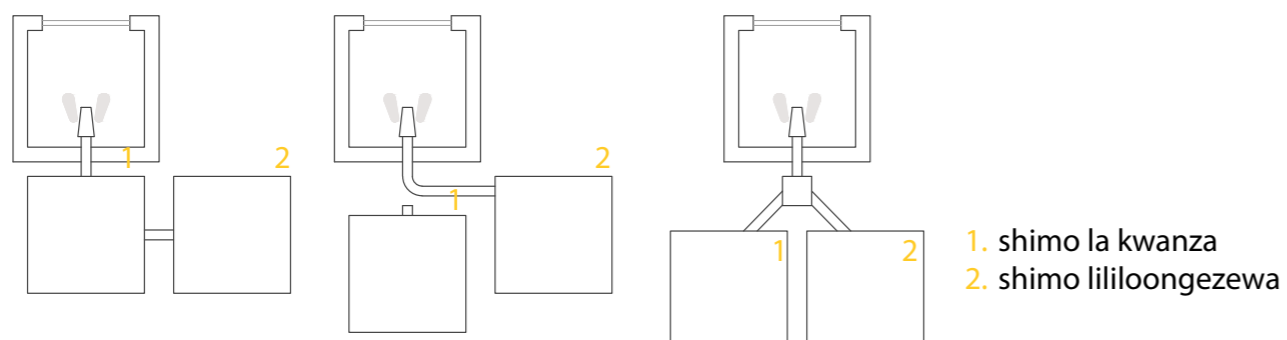

Aina mbalimbali za mashimo:

Shimo la hapohapo

Zuri kwa choo cha shimo cha kawaida (choo cha shimo kilichoboreshwa chenye bomba la kutolea hewa)

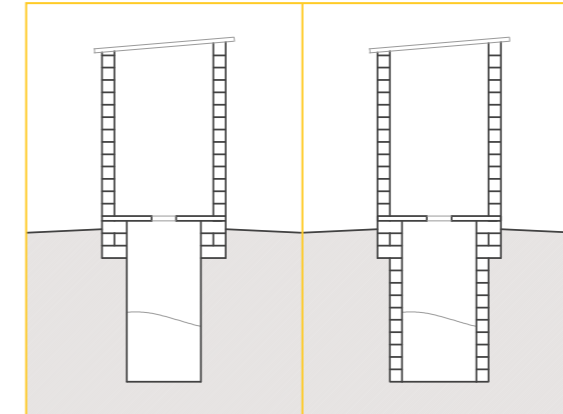

Shimo la hapohapo
lisilojengewa

shimo la hapohapo
lililojengewa

Shimo la pembeni

Zuri kwa choo cha asili kilichoboreshwa cha kumwagia maji chenye bomba

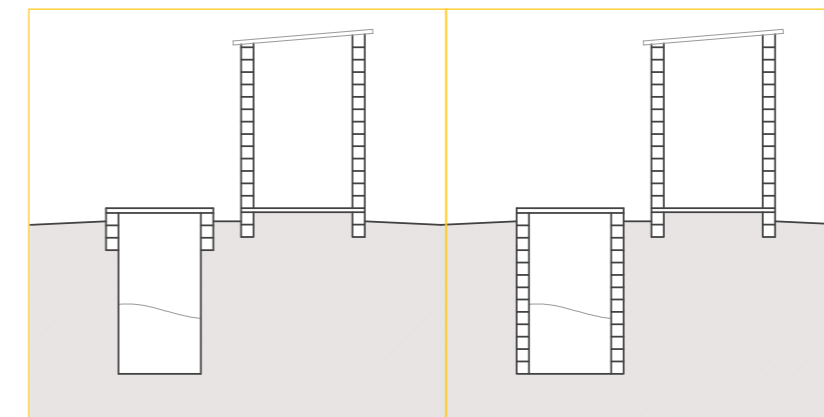

Shimo la pembeni
lisilojengewa

shimo la pembeni
lisilojengewa

Shimo dogo la maji taka na shimo kubwa la maji taka

Zuri kwa choo cha kumwagia maji

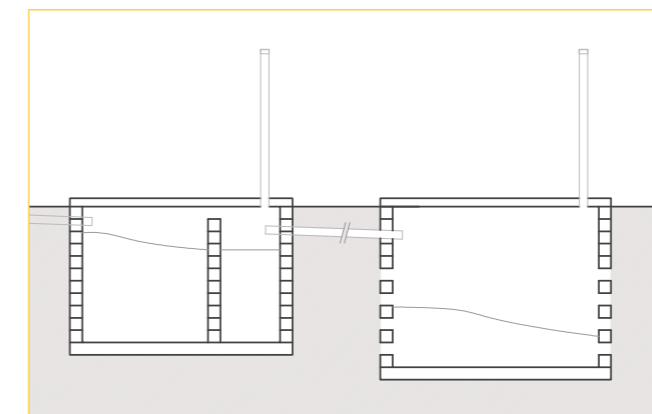

Shimo dogo la
maji taka

Shimo kubwa la
maji taka

Shimo la hapohapo lililojengewa sehemu ya juu tu (1x1x3 = 3 m³)



Maelezo	Wingi	Kimoja	Bei*	Kiasi*
Shimo				
Kuchimba	3	m ³		15,000 Tsh
Matofali ya kuchoma	80	piece	100 Tsh	8,000 Tsh
Sementi	10	Kg	16,500 Tsh	3,300 Tsh
Mchanga	3.5	ndoo	250 Tsh	875 Tsh
Maji	4	ndoo	150 Tsh	600 Tsh
Gharama ya fundi kwa kujengea juu ya shimo (ya gharama zakuchimba shimo zimetolewa)				15,000 Tsh
Jumla				42,775 Tsh

. mchanganyo wa uwiano: 1:7

Shimo lililojengewa sehemu ya juu tu kwa matofali ya kuchoma (1,2x1,2x3 = 4,3 m³)

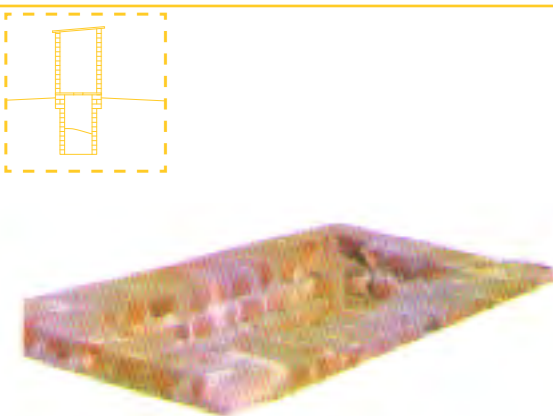

Maelezo	Wingi	Kimoja	Bei*	Kiasi*
Kuchimba	4,3	m ³		20,000 Tsh
Matofali ya kuchoma	384	piece	100 Tsh	38,400 Tsh
Sementi	2	mifuko	16,500 Tsh	33,000 Tsh
Mchanga	34	ndoo	250 Tsh	8,500 Tsh
Maji	30	ndoo	150 Tsh	4,500 Tsh
Gharama ya fundi kwa kujengea juu ya shimo (ya gharama zakuchimba shimo zimetolewa)				25,000 Tsh
Jumla				129,400 Tsh

. mchanganyo wa uwiano: 1:7

Shimo la pembeni lililojengewa kwa juu tu ili kuweka bamba (1x1x3 = 3 m³)



Maelezo	Wingi	Kimoja	Bei*	Kiasi*
Shimo				
Kuchimba	3	m ³		15,000 Tsh
Matofali ya kuchoma	80	piece	100 Tsh	8,000 Tsh
Sementi	10	Kg	16,500 Tsh	3,300 Tsh
Mchanga	3.5	ndoo	250 Tsh	875 Tsh
Maji	4	ndoo	150 Tsh	600 Tsh
Gharama ya fundi kwa kujengea juu ya shimo				15,000 Tsh
Jumla				42,775 Tsh
Mfuniko				
Sementi	0.5	mfuko	16,500 Tsh	8,250 Tsh
Mchanga	5	ndoo	250 Tsh	1,250 Tsh
Kokoto	10	ndoo	300 Tsh	3,000 Tsh
Miti	8	piece	500 Tsh	4,000 Tsh
Mfuko au line	2	piece	200 Tsh	400 Tsh
Maji	4	ndoo	150 Tsh	600 Tsh
Bomba PVC 4"	1.5	m	2,500 Tsh	3,750 Tsh
Gharama ya fundi kwa Mfuniko				3,000 Tsh
Jumla				24,250 Tsh
Jumla				67,025 Tsh

. mchanganyo wa uwiano shimo 1:7
. mchanganyo wa uwiano mfuniko 1:4:8

Shimo la pembeni lililojengewa (1,2x1,2x3 = 3 m³)



Maelezo	Wingi	Kimoja	Bei*	Kiasi*
Shimo				
Kuchimba	4,3	m ³		20,000 Tsh
Matofali ya kuchoma	384	piece	100 Tsh	38,400 Tsh
Sementi	2	mfuko	16,500 Tsh	33,000 Tsh
Mchanga	34	ndoo	250 Tsh	8,500 Tsh
Maji	30	ndoo	150 Tsh	4,500 Tsh
Gharama ya fundi kwa kujengea juu ya shimo				25,000 Tsh
Jumla				129,400 Tsh
Mfuniko wa shimo				
Sementi	0.5	mfuko	16,500 Tsh	8,250 Tsh
Mchanga	5	ndoo	250 Tsh	1,250 Tsh
Kokoto	10	ndoo	300 Tsh	3,000 Tsh
Miti	8	piece	500 Tsh	4,000 Tsh
Mifuko ua nailoni	2		200 Tsh	400 Tsh
Maji	4	ndoo	150 Tsh	600 Tsh
Bomba PVC 4"	1.5	m	2,500 Tsh	3,750 Tsh
Gharama ya fundi kwa mfuniko				3,000 Tsh
Jumla				24,250 Tsh
Jumla				153,650 Tsh

. mchanganyo wa uwiano shimo 1:7
. mchanganyo wa uwiano mfuniko 1:4:8

Shimo dogo la maji taka na shimo kubwa la maji taka



Shimo dogo la maji taka

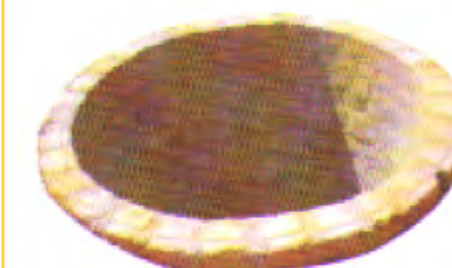

Shimo Kubwa la maji taka

. mchanganyo wa uwiano shimo 1:7
. mchanganyo wa uwiano mfuniko 1:4:8

Maelezo	Wingi	Kimoja	Bei*	Kiasi*
Shimo la maji takadogo (1.2 x 2.4 x 2.4 = 7 m³)				
Kuchimba	7	m ³		60,000 Tsh
Matofali ya kuchoma	600	piece	100 Tsh	60,000 Tsh
Sementi	8	mfuko	16,500 Tsh	132,000 Tsh
Mchanga	126	ndoo	250 Tsh	31,500 Tsh
Kokoto	30	ndoo	300 Tsh	9,000 Tsh
Maji	100	ndoo	150 Tsh	15,000 Tsh
Wavu	1	piece	17,000 Tsh	17,000 Tsh
Nondo 12mm	1	piece	16,000 Tsh	16,000 Tsh
Gharama ya fundi kwa Septic tank				150,000 Tsh
Jumla				490,500 Tsh
Shimo la maji taka kubwa (kipenyo = 2.5 m // kina = 3 m)				
Kuchimba	23.5	m ³		80,000 Tsh
Matofali ya kuchoma	600	piece	100 tsh	60,000 Tsh
Sementi	0.5	mfuko	16,500 Tsh	8,250 Tsh
Mchanga	126	ndoo	250 Tsh	31,500 Tsh
Kokote	30	ndoo	300 Tsh	3,000 Tsh
Maji	100	ndoo	150 Tsh	15,000 Tsh
Wavu	1	piece	17,000 Tsh	34,000 Tsh
Nondo 12mm	4	piece	16,000 Tsh	64,000 Tsh
Baindingi Waya	1	Kg	3,000 Tsh	3,000 Tsh
Mbao pana 1"x8"	8	piece	14,000 Tsh	112,000 Tsh
Mbao 2"x4"	2	piece	7,500 Tsh	15,000 Tsh
Silingi bodi	1	piece	15,000 Tsh	15,000 Tsh
Misumari 2"	0.5	Kg	4,000 Tsh	2,000 Tsh
Gharama ya fundi kwa Soakaway				200,000 Tsh
Jumla				642,750 Tsh
Jumla				1,133,250 Tsh

*Gharama inaweza kubadilika kulingana na bei ya malighafi. Wilaya ya Chamwino 2014

KICHANJA

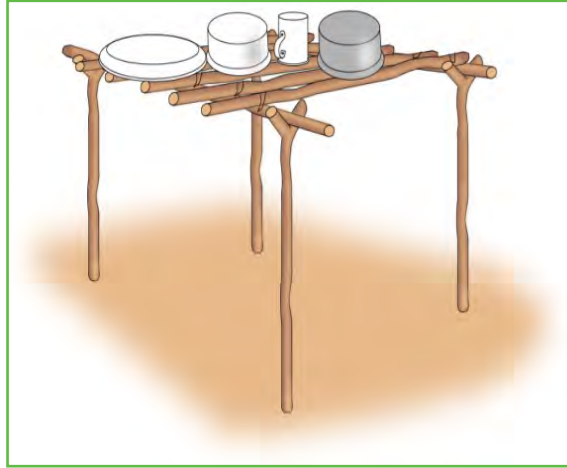

Vichanja ni muhimu kwa kuanikia vyombo mara vioshwapo ili kuruhusu maji kuchuruzika kwa urahisi na kufanya vyombo viwe vimekauka tayari kwa kuhifadhiwa ndani. Kichanja mara nyingi hujengwa karibu na jiko na kwa kutumia rasilimali zinazopatikana katika mazingira husika, rasilimali hizo ni miti na kamba, mahali pengine penye upatikanaji wa mbao hutumia mbao na misumali kutengenezea kichanja.

SHIMO LA TAKA



Shimo la taka hutumika kwa kutunzia taka ngumu na laini ambalo linapaswa kuchimbwa mbali na nyumba, kina cha shimo hili ni kati ya futi nne mpaka sita kutegemea na ardhi ya eneo husika na mwananchi anashauliwa kuchoma moto taka hizo zikiwa ndani ya shimo ili kumruhusu kuendelea kutumia na kuendelea kuhifadhi mazingira kwa kutochimba mashimo mengi katika eneo la nyumba yake. Kucho-ma moto taka hizo kutasaidia kupungunza nzi na wadudu wengine wanafuata taka hizo.

Bamba kwa kuboresha choo:

- Bamba dogo la Sungura na Mfuniko wake
- Mbadala wa bamba dogo la sungura na mfuniko wake

Bamba kwa ajili ya ujenzi wa choo kipyaa:

- . Bamba kubwa la Sungura
- . Bamba la asili la kumwagia maji
- . Sinki

Ushauri kwa ujenzi wa choo:

. Ili kufanya maji ya tiririke kuelekea kwenye shimo la choo, Bamba liwe na mbonyeo kuelekea kwenye shimo la choo (kwa asilimia 5%)

Mionekano mbalimbli ya matundu ya mabamba ya vyoo:

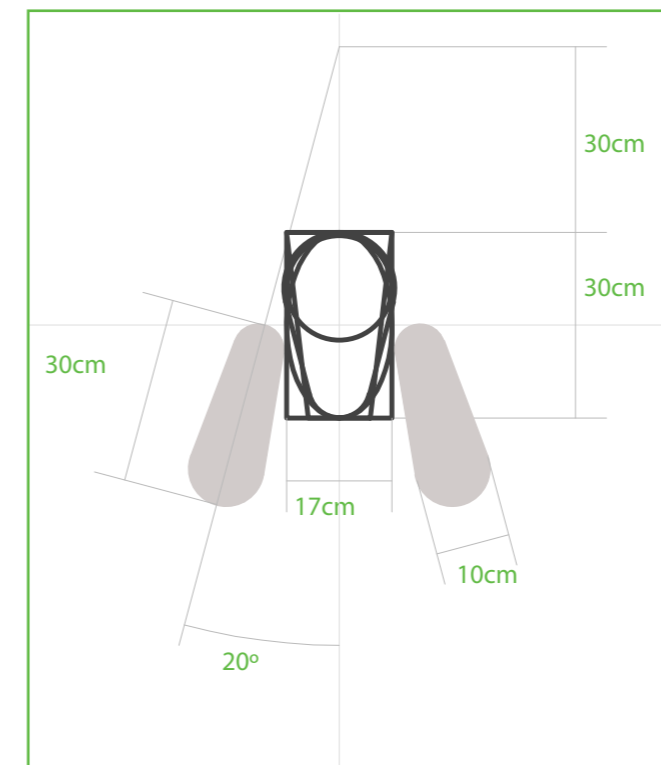
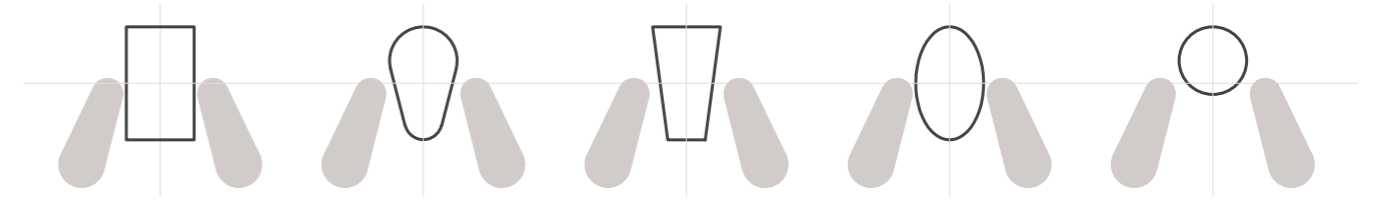

Vipimo vinavyoonyeshwa pembeni ya mchoro huo, vitakusaidia kutengeneza kwa umakini makanyagio ya miguu kwenye Bamba.

. Visigino vya miguu vinatakiwa vianzie kati - kati ya Tundu la bamba

. Umbali kati ya makanyagio na katikati ya tundu la choo uwe unakaribiana kwa nyuzi 20

. Ukubwa wa tundu la choo unashauriwa kuwa na urefu sentimeta 30 na upana sentimeta 17

Sanplat slab - cement



. Mchanganyo wa uwiano 1:2:2



Bamba la Sungura na mfuniko

Maelezo	Wingi	Kimoja	Bei*	Kiasi*
Simenti	4	Kg	330 Tsh	1,320 Tsh
Mchanga	1	ndoo	250 Tsh	750 Tsh
Kokoto	1	ndoo	300 Tsh	450 Tsh
Maji	1	ndoo	100 Tsh	100 Tsh
Wavu	0.6 x 0.6	m ²	5,718 Tsh	2,060 Tsh
Gharama ya fundi				1,500 Tsh
Jumla kuu				5,530 Tsh

- . Mfuniko au sungura unatakiwa kuwa imara ili kuhimili uzito wa watumiaji
- . Gharama za ziada za bambandogo
- . Inahitaji kivyatulio cha gharama cha plastiki

Re-inforced concrete slab integrated with SanPlan for improved latrine & VIP



. Mchanganyo wa uwiano 1:3:3



Bamba kubwa

Maelezo	Wingi	Kimoja	Bei*	Kiasi*
Simenti	16	ndoo	330 Tsh	5,250 Tsh
Mchanga	3	ndoo	250 Tsh	750 Tsh
Kokoto	3	ndoo	300 Tsh	900 Tsh
Maji	4	ndoo	100 Th	400 Tsh
Wavu	1.2 x 1.2	m ²	5,718 Tsh	8,240 Tsh
Pipe PVC 4"	2	m	2,500 Tsh	5,000 Tsh
Gharama ya fundi				5,000 Tsh
JU MLA				25,540 Tsh

-Inatakiwa kuwa imara zaidi iweze kumbeba mtumiaji

Sanplat slab - cement



. Mchanganyo wa uwiano 1:3:3



Mbadala wa Bamba la Sungura ndogo na mfuniko

Maelezo	Wingi	Kimoja	Bei*	Kiasi*
Simenti	4	Kg	330 Tsh	1,320 Tsh
Mchanga	1	ndoo	250 Tsh	750 Tsh
Kokoto	1	ndoo	300 Tsh	450 Tsh
Maji	1	ndoo	100 Tsh	100 Tsh
Wavu	0.6 x 0.6	m ²	5,718 Tsh	2,060 Tsh
Gharama ya fundi				1,500 Tsh
Jumla kuu				5,530 Tsh

- . Mfuniko au bamba unatakiwa kuwa imara ili kuhimili uzito wa watumiaji
- . Gharama za ziada za bambandogo

Ceramic WC for pour flush latrine



. Mchanganyo wa uwiano 1:2



Sinki

Maelezo	Wingi	Kimoja	Bei*	Kiasi*
Sinki	1	Kipande	18,000 Tsh	18,000 Tsh
Mtego maji (P-trap)	1	Kipande	5,000 Tsh	5,000 Tsh
Simenti	20	Kg	330 Tsh	6,600 Tsh
Mchanga	3	ndoo	250 Tsh	750 Tsh
Maji	1	ndoo	100 Tsh	100 Tsh
Bomba PVC 4"	3	m	2,500 Tsh	7,500 Tsh
Gharama ya fundi				15,000 Tsh
JU MLA				52,950 Tsh

- . Kusafisha kwa vitu vigumu vinaweza kuziba mfumo choo
- . Maji ya kufuria, kuogea au mengineyo yanaweza kutumika kumwagia chooni



. Mchanganyo wa uwiano 1:7



Bamba la asili la kumwagia maji

Maelezo	Wingi	Kimoja	Bei*	Kiasi*
Simenti	12.5	Kg	330 Tsh	4,125 Tsh
Mchanga	6	ndoo	250 Tsh	1500 Tsh
Matofali ya kuchoma	20	Kipande	100 Tsh	2,000 Tsh
Maji	3	ndoo	150 Tsh	300 Tsh
Bomba PVC 4"	2	m	2,500 Tsh	5,000 Tsh
Gharama ya fundi				10,000 Tsh
Jumla kuu				22,925 Tsh

- . Kusafisha kwa vitu vigumu vinaweza kuziba mfumo wa choo
- . Maji ya kufuria, kuogea au mengineyo yanaweza kutumika kumwagia chooni



Mfuniko wa mbaao

Jumla kuu 3,000 Tsh



- . Mfuniko unatakiwa kufunika shimo lote bila kuacha nafasi ya kuingiza wadudu kama inzi na wengine

*Gharama inaweza kubadilika kulingana na bei ya malighafi. Wilaya ya Chamwino 2014.

Kibanda



Kwa kawaida ukubwa wake:
1,5 x 1,5 x 2,2 m

***Kupiga ripu:**

Ina shauriwa kupiga lipu kwenye ukuta kwa uimara zaidi.

Maelezo	Wingi	Kimoja	Bei*	Kiasi*
Simenti	2	Mfuko	16,500 Tsh	33,000 Tsh
Mchanga	42	ndoo	250 Tsh	10,500 Tsh
Maji	15	ndoo	100 Tsh	1,500 Tsh
Gharama ya fundi				20,000 Tsh
Jumla kuu				65,000 Tsh

. Mchanganyo wa uwiano: 1:7

***Kitako:**

Kama shimo ni la pembeni kibanda chake ninahitaji kujengewa kitako.

Maelezo	Wingi	Kimoja	Bei*	Kiasi*
Tofali za kuchoma	80	Kipande	100 Tsh	8,000Tsh
Simenti	10	Kg	330 Tsh	3,300 Tsh
Mchanga	3,5	ndoo	250 Tsh	875 Tsh
Maji	3	ndoo	100 Tsh	300 Tsh
Gharama ya fundi				15,000 Tsh
Jumla kuu				27,475 Tsh

Kibanda kinajengwa kulingana shimo lilivyo:

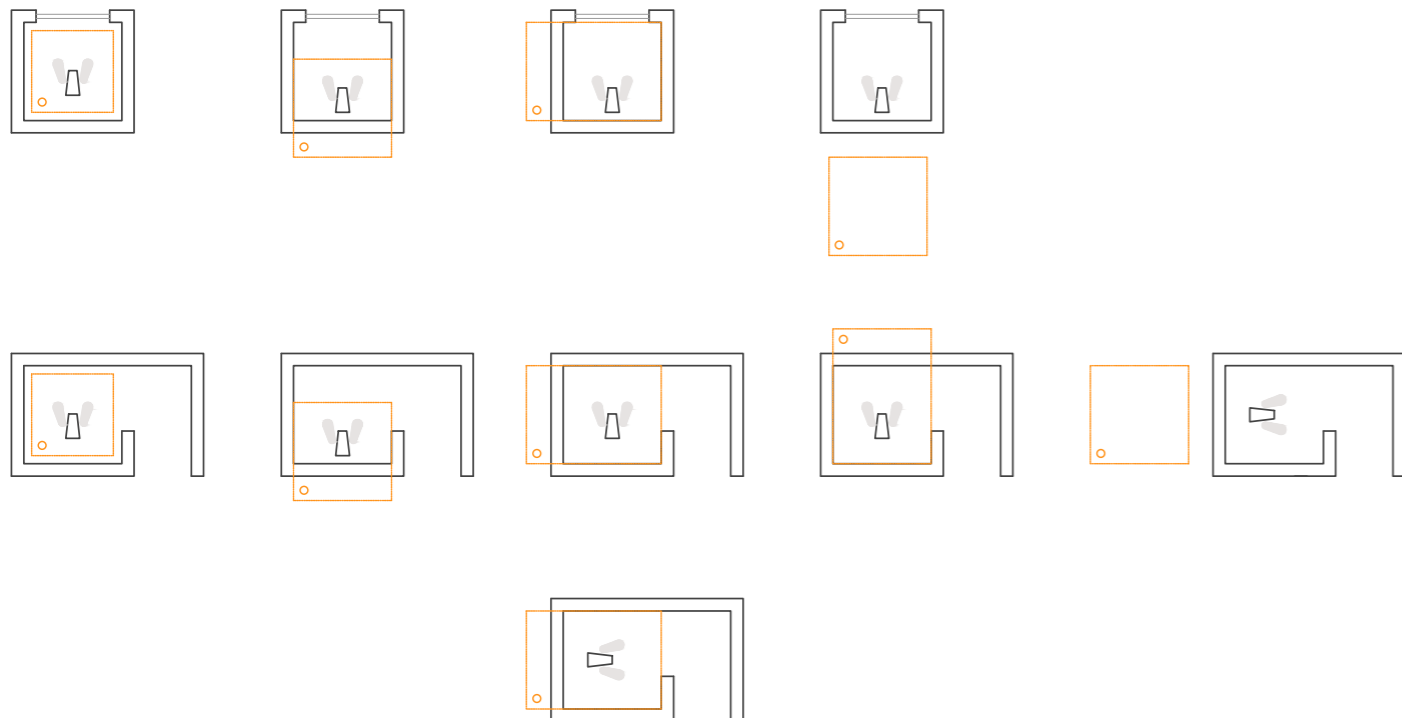

Kibanda cha choo na Bafu:

. Kila kibanda kwenye katalogi kinaweza kujengwa na bafu.



Choo



Choo na bafu

Mlango:

. Milango mingi ambayo hutumika hutengenezwa kwa bati (A) na mbao (B), mlango wa kwanza (A) unapendekezwa kwa sababu gharama zake ni ndogo (nusu) ukilinganisha na wa mbao.



Mlango:

. Nondo zinatakiwa ziunganishwe vizuri na fundi kwenye ukuta ili kupunguza athari zinazoweza kujitokeza kutokana na upepo na mvua kali.
. Vyoo vya Tembe vijengwe vizuri ili kudhibiti mvua isipite wakati wa masika.
. Paa la tembe ni zuri kwa maeneo ambayo upatikanaji wa miti ni rahisi.

*Gharama Halisi za malighafi hazihusishi usafiri. Wilaya ya Chamwino 2014

Kibanda cha tope na tembe



Maelezo	Wingi	Kimoja	Bei*	Kiasi*
Udongo				Tsh
Maji	20	ndoo	2,000 Tsh	2,000 Tsh
Nguzo	4	Kipande	4,000 Tsh	4,000 Tsh
Mapao	4	Kipande	300 Tsh	1,200 Tsh
Nyasi	1	Kipande	3,000 Tsh	3,000 Tsh
Mlango wa bati na fremu	1	Kipande	21,000 Tsh	21,000 Tsh
Bawaba	2	Kipande	1,000 Tsh	2,000 Tsh
Kufuri	1	Kipande	2,000 Tsh	2,000 Tsh
Fito	100	Kipande	30 Tsh	3,000 Tsh
Mwamba	2	Kipande	1,000 Tsh	2,000 Tsh
Gharama ya fundi				20,000 Tsh
		JUMLA		60,200 Tsh

Kibanda cha matofali mabichi and tembe



Maelezo	Wingi	Kimoja	Bei*	Kiasi*
Matofali ya udongo	400	Kipande	50 Tsh	20,000 Tsh
Maji	20	ndoo	100 Tsh	2000 Tsh
Matawi ya miti	6	Kipande	1,000 Tsh	6,000 Tsh
Nguzo za miti	4	Kipande	1,000 Tsh	4,000 Tsh
Nyasi	1	Kipande	3,000 Tsh	3,000 Tsh
Mlango wa bati na fremu	1	Kipande	21,000 Tsh	21,000 Tsh
Bawaba	2	Kipande	1,000 Tsh	2,000 Tsh
Kufuri	1	Kipande	2,000 Tsh	2,000 Tsh
Mapao	4	Kipande	300 Tsh	1,200 Tsh
Fito	100	Kipande	30 Tsh	3,000 Tsh
Gharama ya fundi				20,000 Tsh
		JUMLA		84,200 Tsh

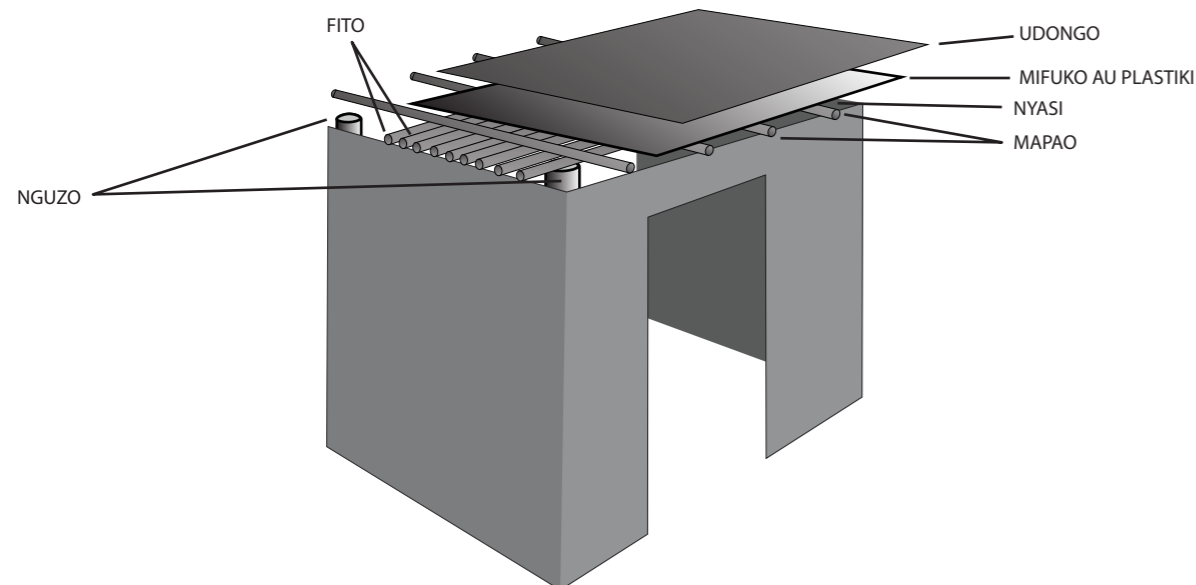

Kibanda cha matofali mabichi na bati



Maelezo	Ya wingi	kwa kila	Bei*	Kiasi*
Matofali ya udongo	400	Kipande	50 Tsh	20,000 Tsh
Udongo	-	-	-	-
Maji	20	ndoo	100 Tsh	2,000 Tsh
Bati	2	Kipande	12,000 Tsh	24,000 Tsh
Misumari	0.5	Kg	750 Tsh	1,500 Tsh
Mbao (2" x 4")		Kipande	7000 Tsh	14,000 Tsh
Bawaba	2	Kipande	1,000 Tsh	2,000 Tsh
Mlango wa bati na fremu	1	Kipande	21,000 Tsh	21,000 Tsh
Kufuri	1	Kipande	2,000 Tsh	2,000 Tsh
Gharama ya fundi				50,000 Tsh
		JUMLA		136,500 Tsh

Kibanda na matofali ya kuchoma na bati



Maelezo	Wingi	Kimoja	Bei*	Kiasi*
Matofali ya kuchoma	400	Kipande	100 Tsh	4,000 Tsh
Udongo	-	-	-	-
Maji	20	ndoo	100 Tsh	2,000 Tsh
Bati	2	Kipande	12,000 Tsh	24,000 Tsh
Misumari	0.5	Kg	750 Tsh	1,500 Tsh
Mbao (2" x 4")	2	Kipande	7,000 Tsh	14,000 Tsh
Bawaba	2	Kipande	1,000 Tsh	2,000 Tsh
Mlango wa bati na fremu	1	Kipande	21,000 Tsh	21,000 Tsh
Kufuri	1	Kipande	2,000 Tsh	2,000 Tsh
Gharama ya fundi				50,000 Tsh
		JUMLA		156,500 Tsh

Kibanda cha matofali ya simenti na bati



. mchanganyo wa uwiano: 1:7

Maelezo	Wingi	Kimoja	Bei*	Kiasi*
Matofali ya simenti na mchanga	110	Kipande	1,000 Tsh	110,000 Tsh
Simenti	2.5	mfuko	16,500 Tsh	41,250 Tsh
Mchanga	51	ndoo	250 Tsh	12,750 Tsh
Maji	20	ndoo	100 Tsh	2,000 Tsh
Mbao (2" x 4")	2	Kipande	7,000 Tsh	14,000 Tsh
Mlango wa bati na fremu	1	Kipande	21,000 Tsh	21,000 Tsh
Bawaba	2	Kipande	1,000 Tsh	2,000 Tsh
Bati	2	Kipande	12,000 Tsh	24,000 Tsh
Misumari	0.5	Kg	4,000 Tsh	2,000 Tsh
Kufuri	1	piece	2,000 Tsh	2,000 Tsh
Gharama ya fundi				60,000 Tsh
		JUMLA		291,000 Tsh



Vitu vya ziada kwa walemavu

. Walemavu wanaweza kutumia aina yoyote ya choo kama vitajengwa vizuri na kutunzwa vizuri.

Stuli inayoweza kutolewa:

- . Kiti cha mbao: 14,000Tsh
- . Mishikio ya chuma: 5,000Tsh



. Stuli isyotolewa



. Watu Vipofu

. Kamba iliyofungwa kuele - kea chooni.



. Njia lenye alama inayoelekea chooni.



. Sehemu ya kukanyaga yenye mikwaruzo kupunguza kuteleza.

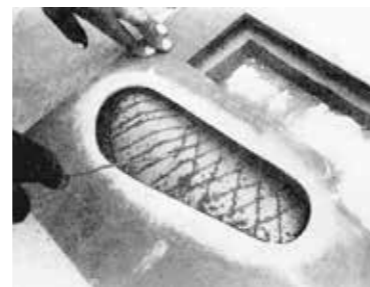

Vifaa vya kufagilia:



- . Ndoo yenye maji safi na vifaa vingine vya usafi.
- . Ufyagio na mti kwa ajili ya kufanyia usafi.
- . Chombo cha kuwekea takataka.



Ili kuwa salama ni vyema kutumia choo chenye kinawia mikono



Tip-tap

Description	Wingi	Kimoja	Bei*	Kiasi*
Matawi ya miti	3	Kipande	500 Tsh	1,500 Tsh
Chupa	1	Kipande	1,500 Tsh	1,500 Tah
Kamba		m		500 Tsh
			Jumla kuu	3,500 Tsh

Ndoo yenye koki



Description	Wingi	Kimoja	Bei*	Kiasi*
Ndoo	1	Kipande	2,500 Tsh	2,500 Tsh
Koki	1	Kipande	4,500 Tsh	4,500 Tsh
Stuli	1	Kipande	5,000 Tsh	5,000 Tsh
			Jumla kuu	10,000 Tsh

Kwa kutumia Koki inayoweza kufunguliwa na kufungwa kwa kutumia Kiwiko Maambukizi ya Bakteria toka kwenye mikono yenye maambukizo inazuilika.

Mtungi wenye koki



Maelezo	Wingi	Kimoja	Bei*	Kiasi*
Simenti	1	Mfuko	16,500 Tsh	16,500 Tsh
Mchanga	2	Ndoo	250 Tsh	500 Tsh
Maji	4	Ndoo	100 Tsh	400 Tsh
Koki	1	Kipande	7,000 Tsh	7,000 Tsh
Tofali za kuchoma	20	Kipande	100 Tsh	2,000 Tsh
Nondo 12mm	0.25	m	1,340 Tsh	335 Tsh
Wavu wa kuku	1	m	4,500 Tsh	4,500 Tsh
Gharama ya fundi				8,000 Tsh
			Jumla kuu	39,235 Tsh

*Gharama halisi za malighafi hazihusishi usafiri. Wilaya ya Chamwino 2014



Mwandishi anatoa shukrani kwa watu wote waliompa msaada wakati wa kutengeneza katalogi hii:

Kwanza shukrani za pekee kwa wakazi wa vijiji vya wilaya ya Chamwino kwa ukarimu wao wakati wa kutembelea maeneo yao kwa kuonesha ushirikiano wa kutosha. Kwa msaada wa viongozi wa serikali za vijiji kwa ushirikiano wao na moyo wa kujitua kwa kutuunganisha na jamii.

Shukrani za dhati kwa washiriki wa UMATA, Mradi ambao umeleta muelekeo wa kazi hii, pia kwa PDF na LVIA kwa msaada wao wakati wa utafiti kwa kubadilishana mawazo na uzoefu wa eneo husika, lakini pia kwa shirika la Plan International Tanzania kwa mutongozo, msaada na kuimarisha mahusiano miongoni mwa wadau mbalimbali. Pia tunapenda kuwashukuru shirika la Catholic Relief Services (CRS) na Social and Economic Development Initiative (SEDI) na Community Development and Relief Trust (CODERT) kwa ushirikiano wao.

Wakati wa muendelezo wa ubunifu wa suluhisho la usafi wa mazingira tulikuwa na bahati sana kufanya kazi pamoja na mafundi waliopata mafunzo kupitia kwa wadau mbalimbali kama HPSS kwa Chamwino na wale wa UFUNDIKO kwa Kongwa ambao pia walitupatia ushauri wakati tunarudia toleo la kwanza ili kupata uhalisia wa mambo katika mazingira wanayoishi.

Kimetengenezwa kwa Ushirikiano na:



Grupo de Cooperación de Sistemas de Agua y Saneamiento para el Desarrollo (GCSASD) -

Escuela Técnica Superior de Ingeniería y Diseño Industrial.
Universidad Politécnica de Madrid
C/Ronda de Valencia 3, 28012
Madrid, España

Bsc.Environmental Engineering(EE)

Department of Environmental Engineering
School of Environmental Science and Technology(SEST)
Ardhi University
P.O.BOX 35176 Dar Es Salaam, Tanzania



People's Development Forum (PDF)
Head Office: Sinza Madukani along Shekilango Road,
P.O. Box 55021, Dar es Salaam, Tanzania



ONGAWA

Ingeniería para el desarrollo Humano
C/Vizconde de Matamala 17, 3ªplanta, 28028
Madrid, España

Washiriki:

Zachayo Makobero - Project Manager (**PDF**)
Eng. Suleiman Kidula - Project Manager (**PDF**)
Clemence Mweche - Project Manager (**ONGAWA**)
Lydia Mcharo - Project Coordinator (**Plan International**)
Ana Esteban Zano - Catalogue Coordinator UPM (**ONGAWA**)
Alfonso Zapico - Project Manager Technical Advisor (**ONGAWA**)
Johannes J. Rumitho - Project Officer (**PDF**)
Steven Kiboko - Project Officer (**ONGAWA**)
Tito Mwambala - Project Officer (**ONGAWA**)
Paul Thobias Seleman - Student from Ardhi University

Photographs:

ONGAWA and GCSASD except pg. 28:

1-3. Water Aid/ Jane Wilbur
4. Plan Indonesia / Agus Haru

This work is licensed under the Creative Commons Attribution-NonCommercial 4.0 International Licence.

To view a copy of this license, visit <http://creativecommons.org/licenses/by-nc/4.0/> or send a letter to Creative Commons, 444 Castro Street, Suite 900, Mountain View, California, 94041, USA

Katalogi hii matokeo maalum ya mradi "kufikia uboreshwaji wa usafi wa mazingira kwa wote ambao hawakuweza kufikia ,kupitia utafiti na suluhisho sahihi" umefadhiliwa na Water and Sanitation Systems for Development Cooperartion Group" (GCSASD) of the Polytechnic University of Madrid from its 'XIV' Call for grants for University development cooperation actions 2013"

Lengo maalum ni, kutambua, kuchambua, kuendelea, kuhamasishwa unafuu, ubora na uimara wa suluhisho la usafi wa mazingira katika mazingira ya wilaya ya Chamwino.

Utekelezaji wa kazi umefanyika kwa ushirikiano kati ya PDF, GCSASD, ONGAWA na Chuo Kikuu Cha Ardhi.

Mradi huu unatekelezwa ndani ya mpango wa mradi wa UMATA, ambao unafadhiriwa na GSF, Unalenga kuongeza uwezekano wa matumizi wa vifaa bora vya usafi wa mazingira na kubadili tabia mbaya za usafi wa mazingira kwa ukubwa wake. Umeanzishwa ili kuongeza kampeni ya taifa ya usafi wa mazingira Tanzania, ambapo kwa awamu ya kwanza unatekelezwa katika Wilaya tatu za mkoa wa Dodoma ambazo ni Bahi, Chamwino na Kongwa.

Kuandaliwa kwa katalogi hii ulianza mwezi wa sita hadi mwezi wa kumi na mbili mwaka 2014 katika Wilaya ya Chamwino. Utafiti wa bidhaa za usafi wa mazingira na majaribio yake bado yanafanyika wakati huu ambao kitabu hiki kimetolewa.

Katalogi hii ipo kwa lugha ya kiingereza na Kiswahili. Wasomaji na watumiaji wote wanakaribishwa kutoa maoni na ushauri wao kadri wawezavyo, ili toleo lijalo liweze kuboreshwa kupitia maoni yao, kwa madhumuni hayo na habari zaidi tafadhari tuwasiliane kupitia anuani hizo hapo chini:

Anuani ya Posta: Grupo de Cooperación de Agua y Sanemiento para el Desarrollo
Escuela Técnica Superior de Ingeniería y Diseño Industrial
C/ Ronda de Valencia, 3 28012
Simu: +34 91 336 68 76 / 46
Barua Pepe: cooperacion.agua.etsidi@upm.es
Tovuti: <http://sistemasdeaguaysaneamientoparaeldesarrollo.wordpress.com>

Imetolewa na "Water and Sanitation Systems for Development Cooperation Group" (GCSASD), PDF na ONGAWA.

ISBN: 978-84-697-1719-6

Imefasiriwa na Polytechnic University of Madrid

